

Der Totalschaden

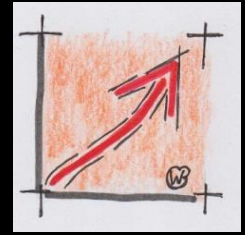

**Baufachforum**  
Wilfried Berger



Bauen ist ein  
stetiger Kampf  
gegen das Wasser

**Viel Vergnügen mit dem Thema:  
Der Totalschaden**

**Geiselmann 1**

Der Totalschaden



# Was ist Bauphysik?

Alles, was wir  
manuell machen  
können oder  
müssen.



Der Totalschaden



# Bauphysik:

**Baufachforum**  
Wilfried Berger

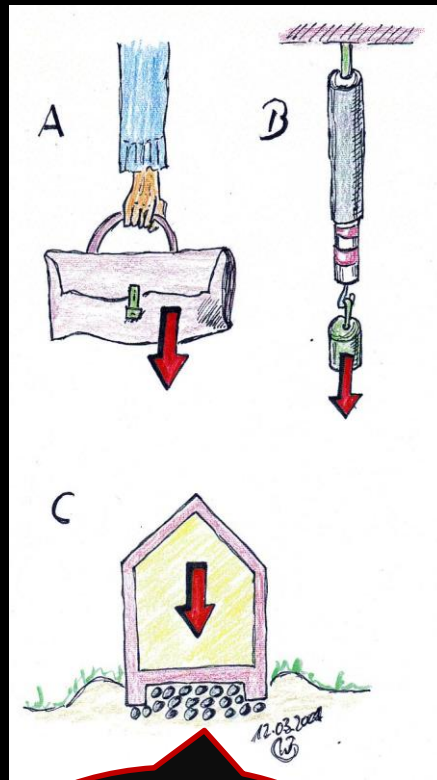
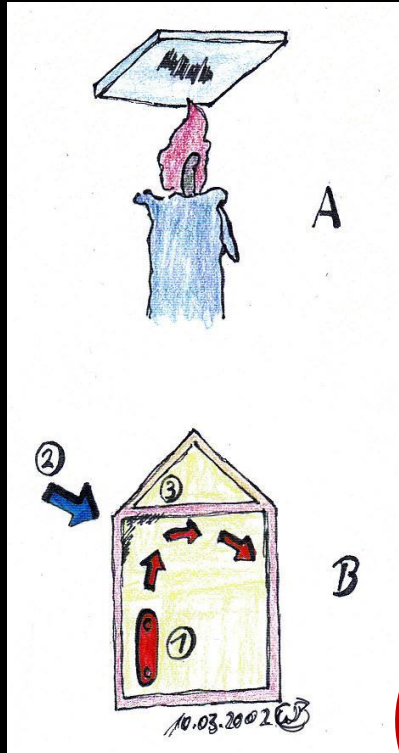
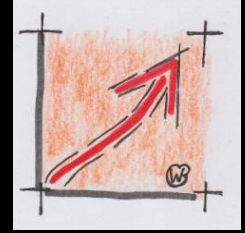

Eine Ausnahmen bei Gewicht bildet die Schwerelosigkeit und Wasser!!!!

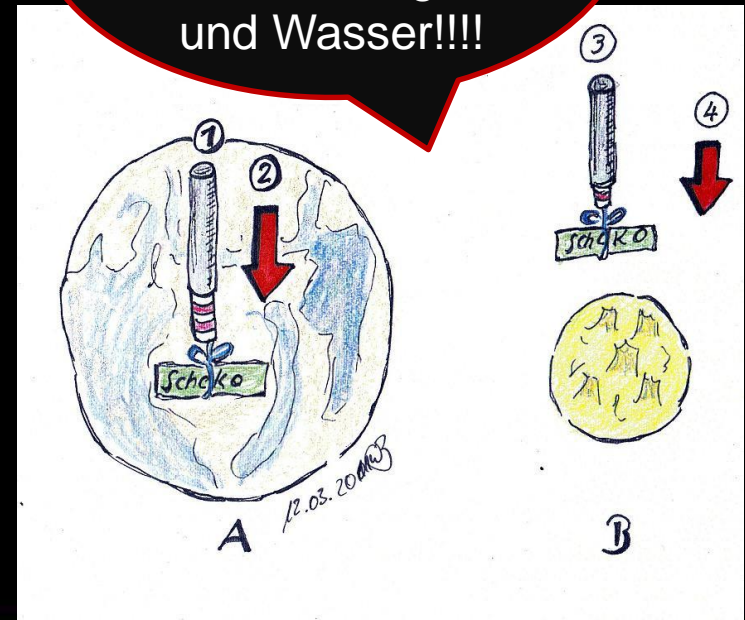

Hier sprechen wir dann im Hausbau von Lasten.

Der Totalschaden

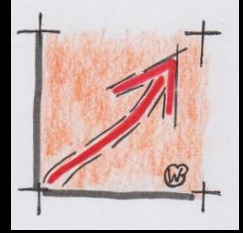

# Was ist Bauchemie:

Alles, was sich aus einer Veränderung durch Atome und Elektronen vorgenommen wird.

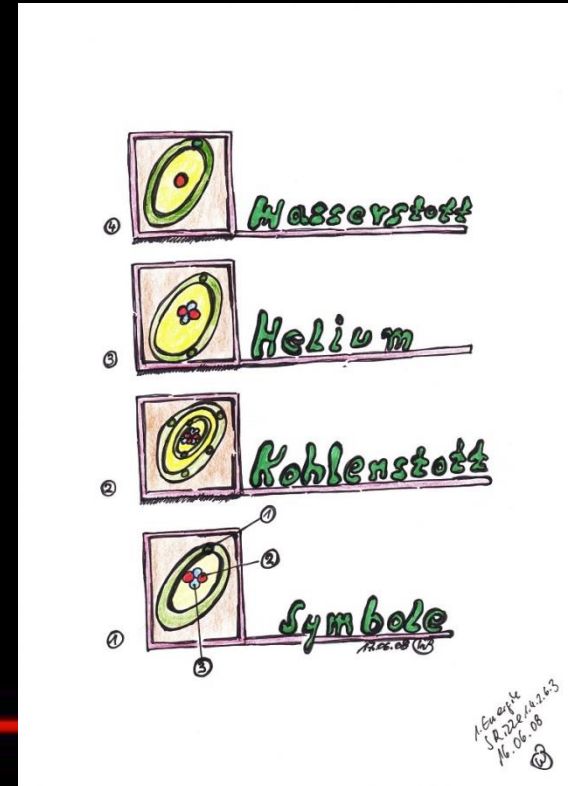
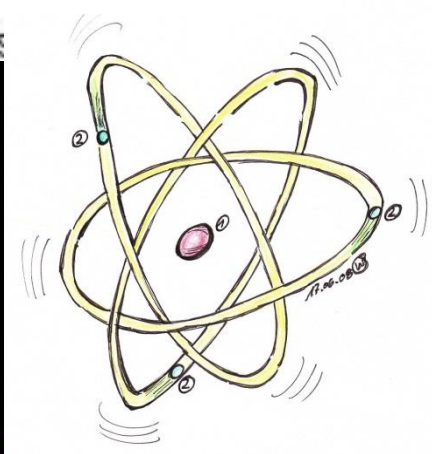
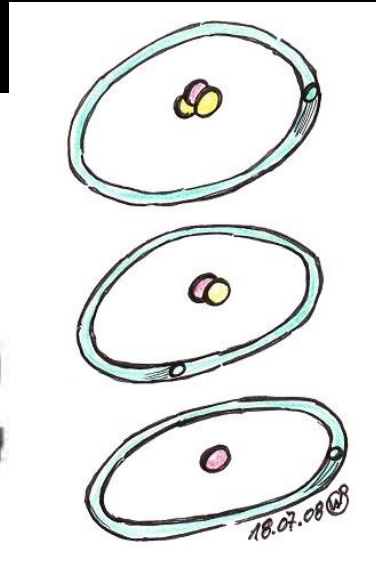

Rost!  
!!!!

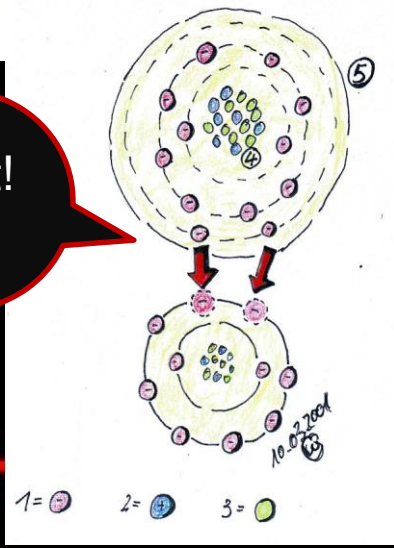

Geisselmann 1

16.06.08  
18.02.08  
16.06.08  
W

Der Totalschaden

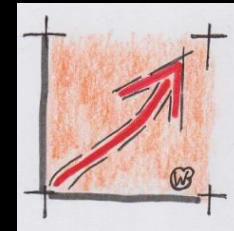

# Die Grenze zwischen Bauphysik und Bauchemie:



Feuchte-  
beseitigung durch  
Physik!

Feuchte-  
beseitigung  
durch  
Chemie!

Bautrocknung:

- Kondenstrocknung
- Kokelöfen

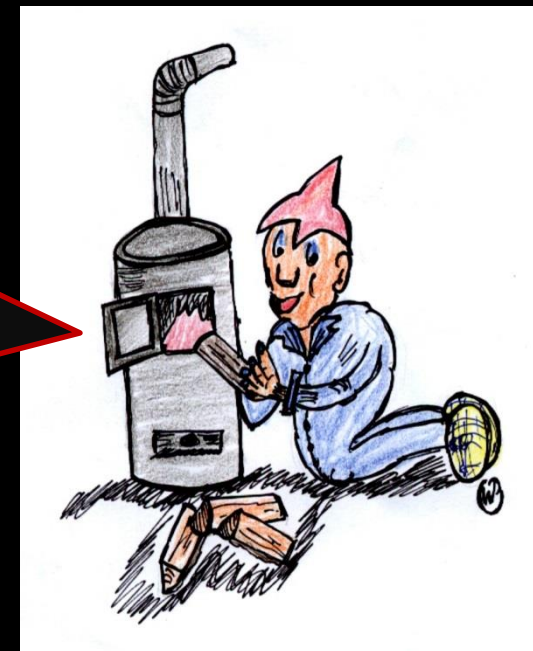

Der Totalschaden

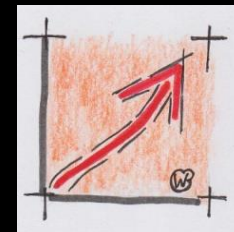

# Bauphysik oder Bauchemie:

## Physikalischer Vorgang

## Chemischer Vorgang

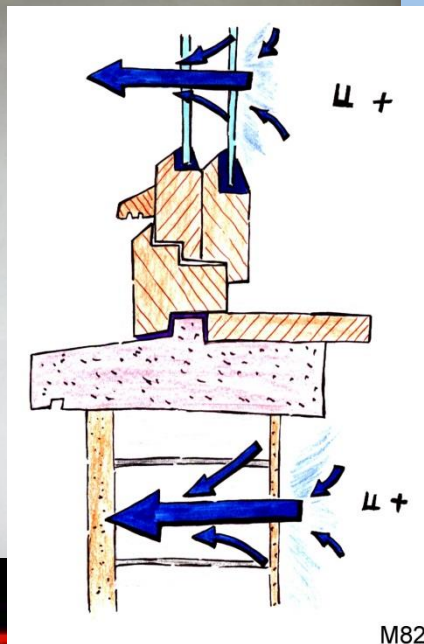
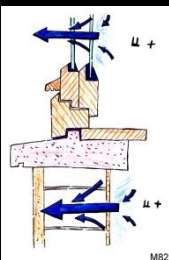

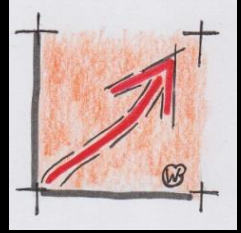

Vorbeugen ist besser  
wie Heilen!!!!

### Variante 1: Soll-Zustand

## GU - Generalunternehmer

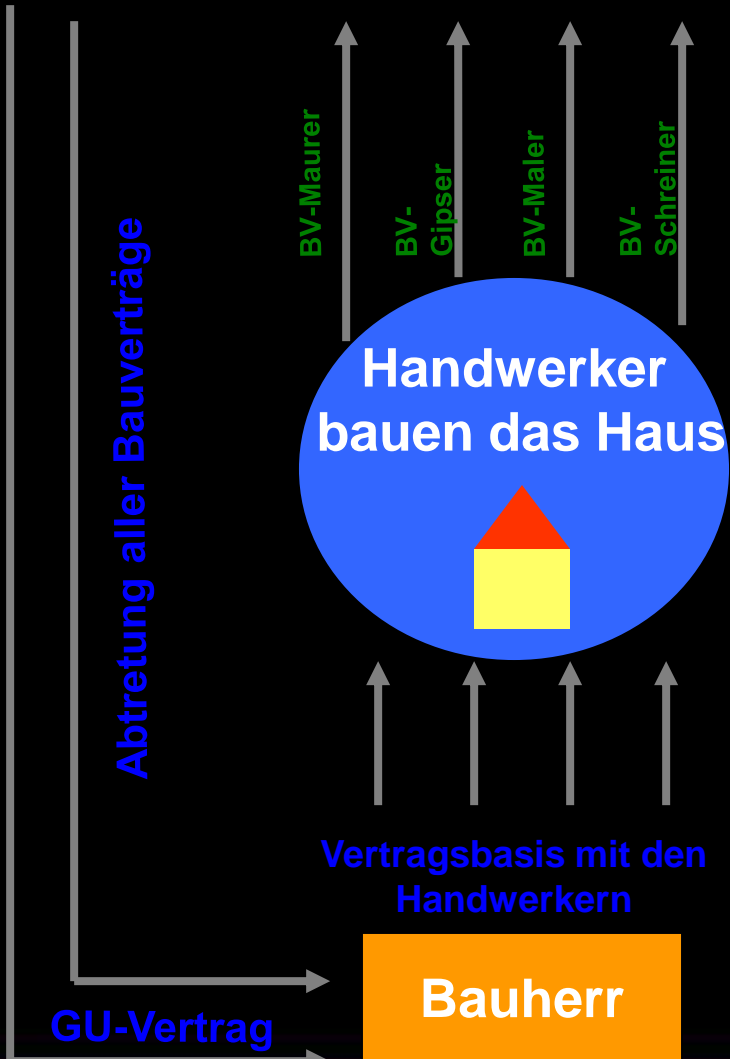

### Variante 2: Ist-Zustand

## GU - Generalunternehmer

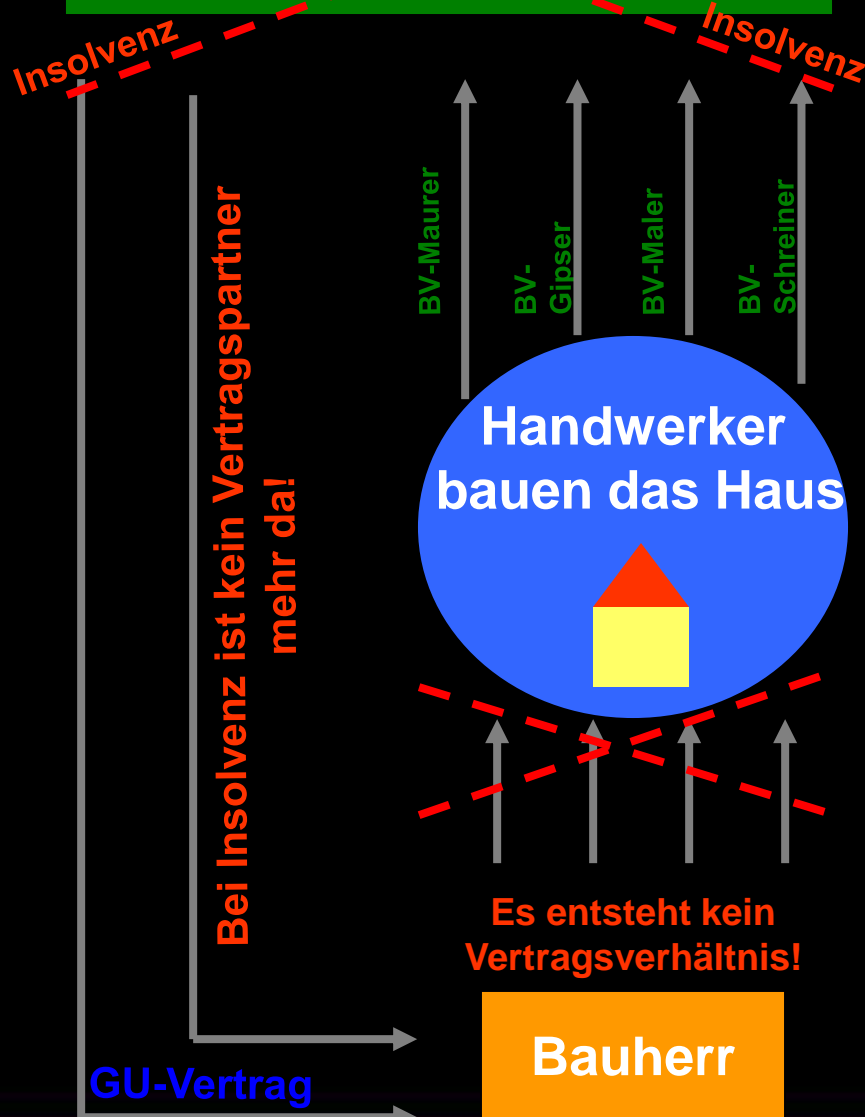



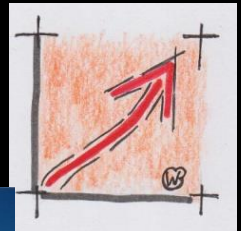

Pläne Lesen:

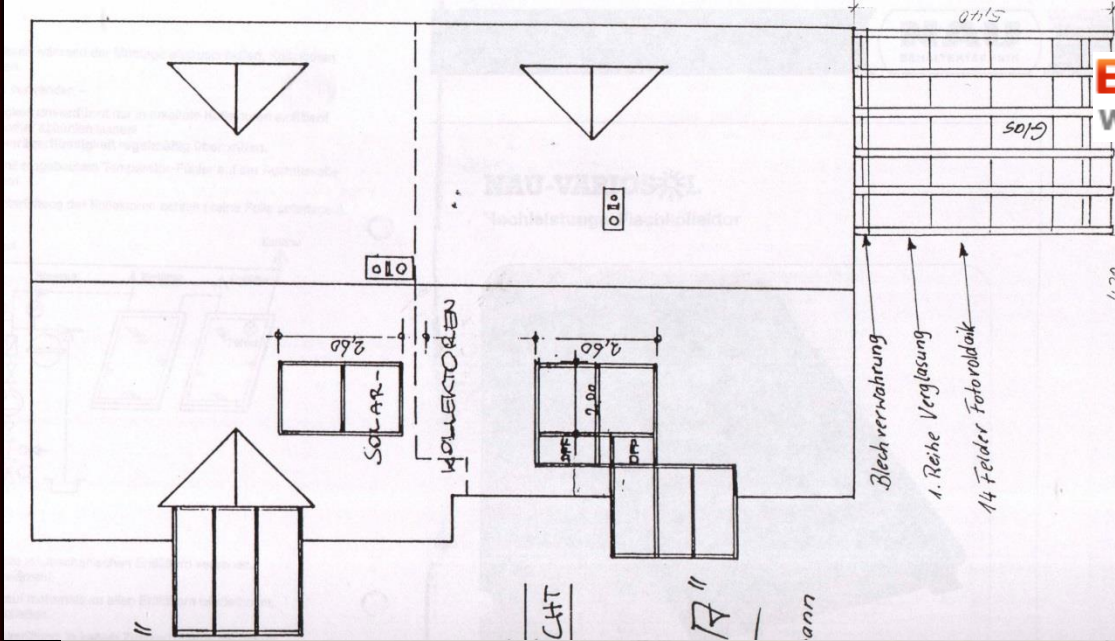

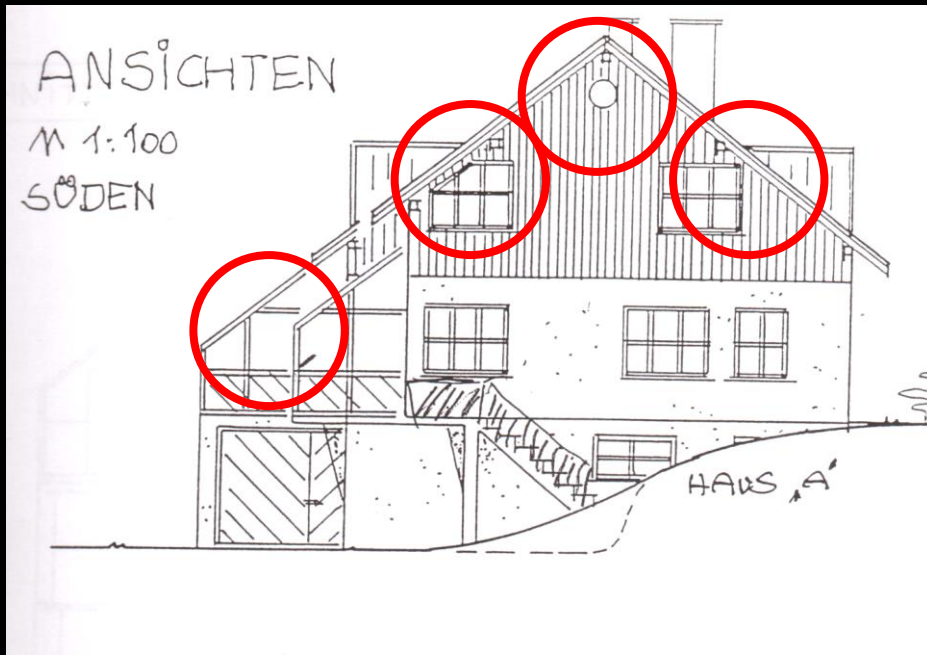

**Baufachforum**  
Wilfried Berger

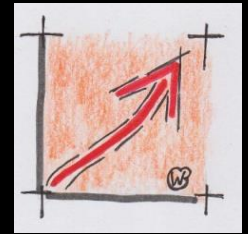

Der Totalschaden

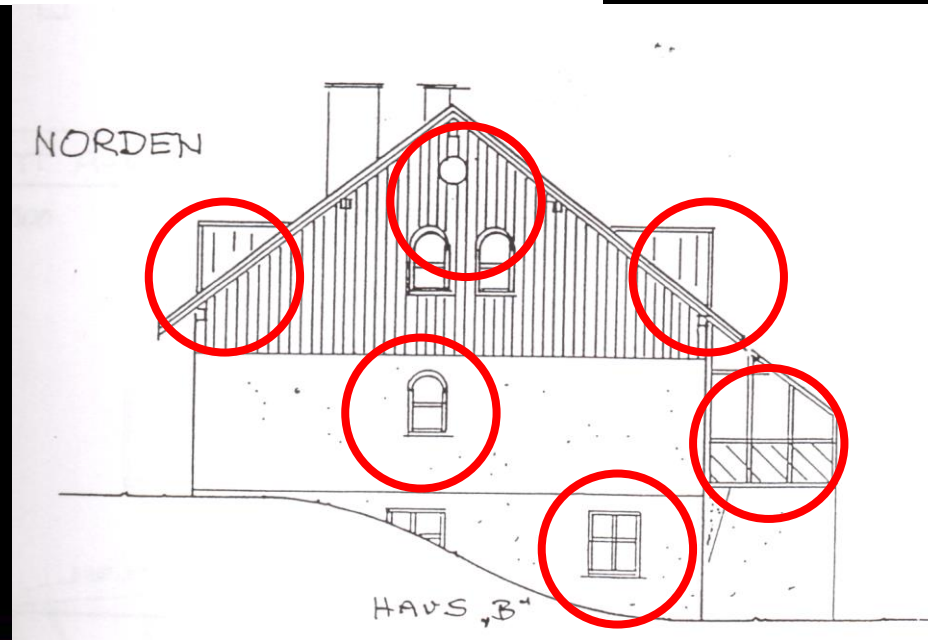

**Geiselman 1**

Der Totalschaden



**Baufachforum**  
Wilfried Berger

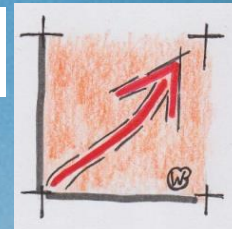

**Geiselmann 1**

Der Totalschaden



**Baufachforum**  
Wilfried Berger

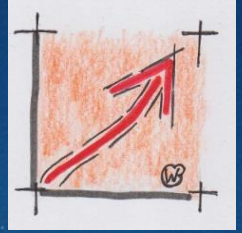

**Geiselman 1**

Der Totalschaden



**Baufachforum**  
Wilfried Berger

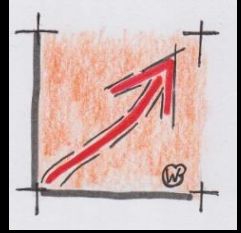

**Geiselmann 1**

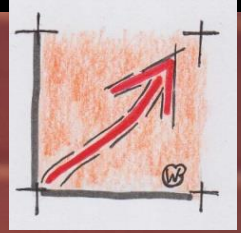

Der Totalschaden



**Baufachforum**  
Wilfried Berger

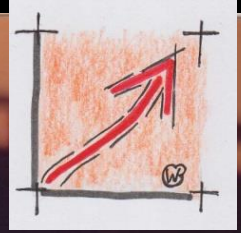

**Geiselman 1**

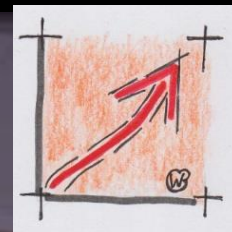



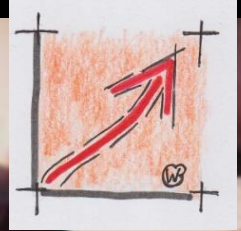

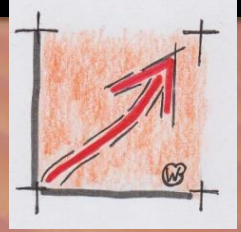

Der Totalschaden



**Baufachforum**  
Wilfried Berger

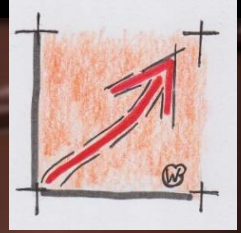

Der Totalschaden

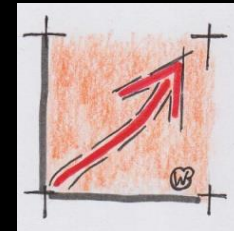

# Das Unterdach:



Ohne Unterdach ist ein Dach/Haus nicht funktionsfähig



Der Totalschaden

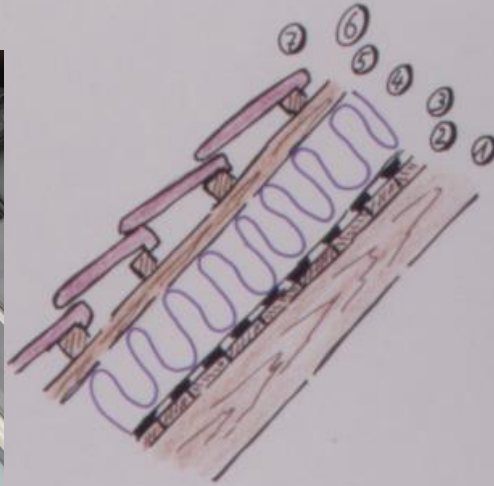

**Baufachforum**  
Wilfried Berger

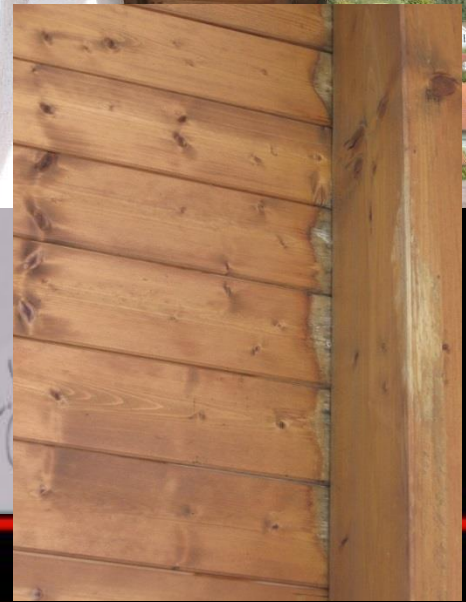
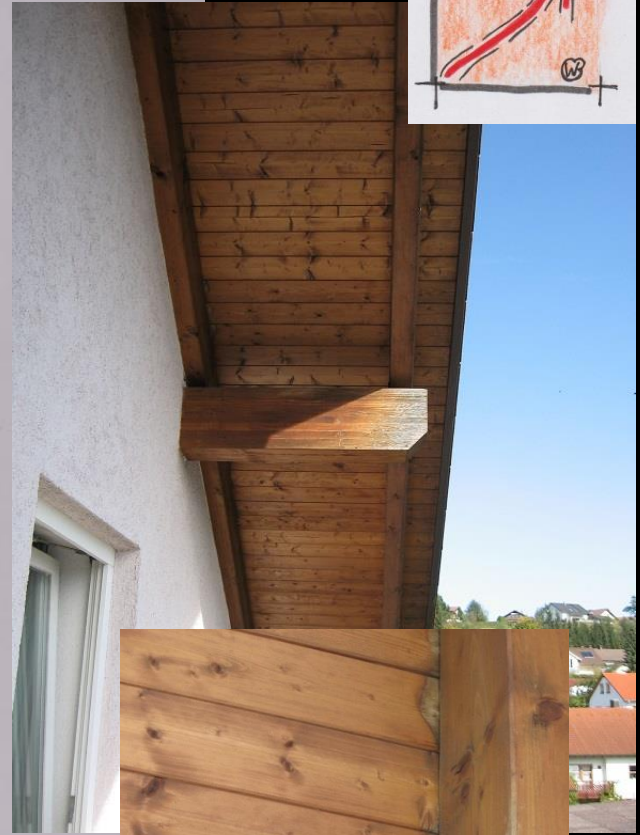
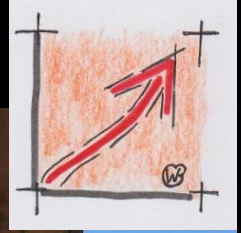

25.02

Der Totalschaden



**Baufachforum**  
Wilfried Berger

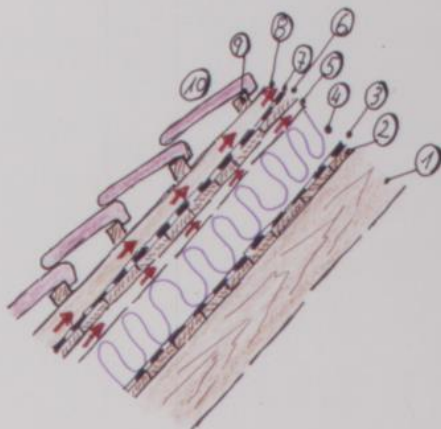
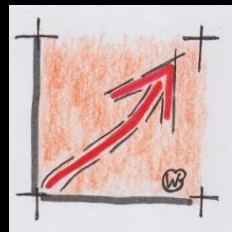

Der Totalschaden



**Baufachforum**  
Wilfried Berger

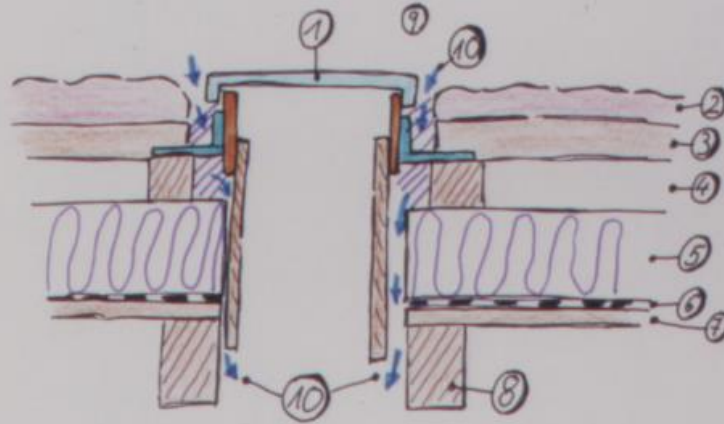
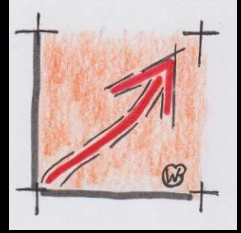

25.02.2002  
W

Der Totalschaden



**Baufachforum**  
Wilfried Berger

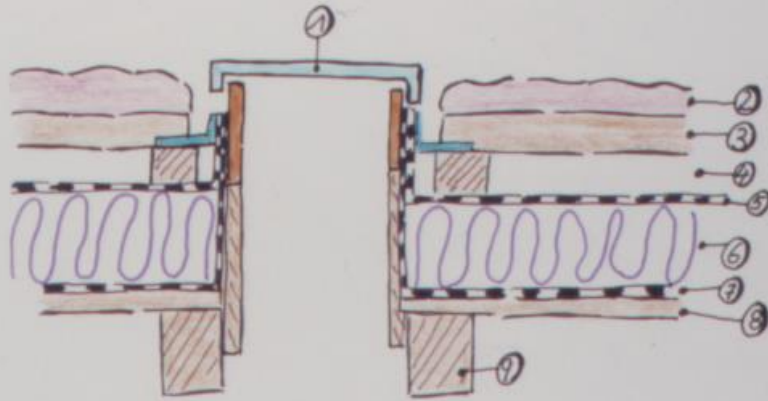
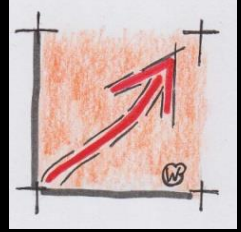

25.02.2002  
[Signature]



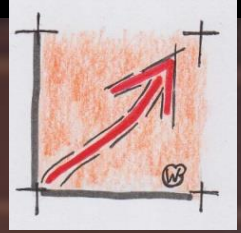

Der Totalschaden



**Baufachforum**  
Wilfried Berger

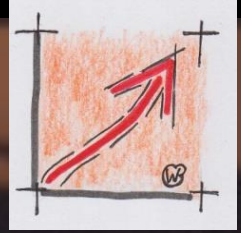

Der Totalschaden



**Baufachforum**  
Wilfried Berger

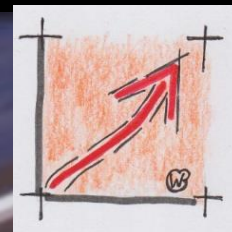

Der Totalschaden

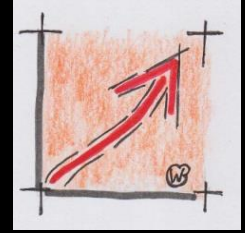

# Der Goldene Schnitt:

- Das Freiburger Münster im Goldenen Schnitt:
- Ein Kapitell im goldenen Schnitt.
- Alles abgeleitet von der Cheops-Pyramide.
- Alles nur eine Sache von Geometrie.
- Perfektion >Die Hagia Sofia<.

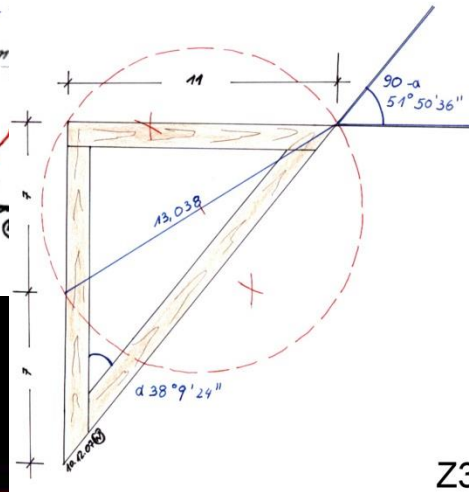
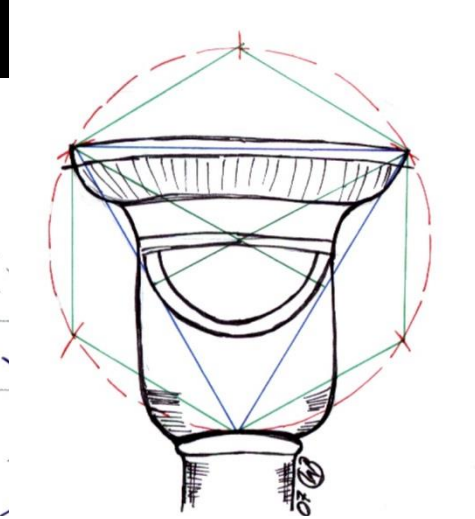
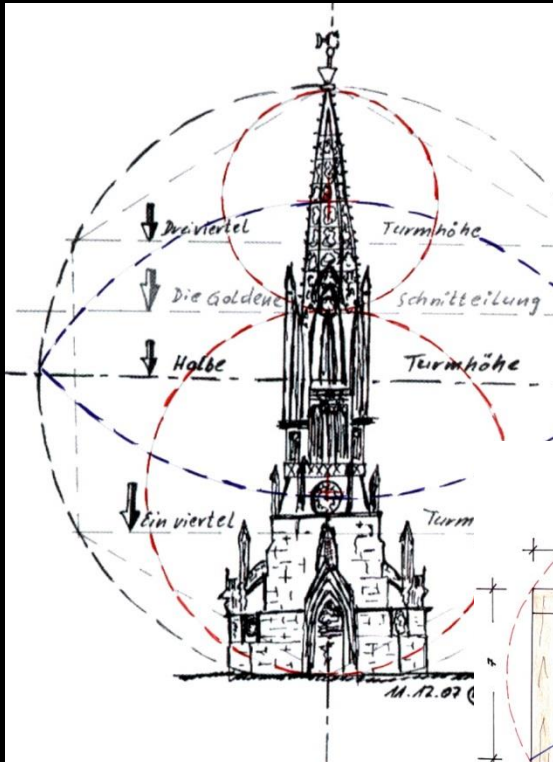

Z2

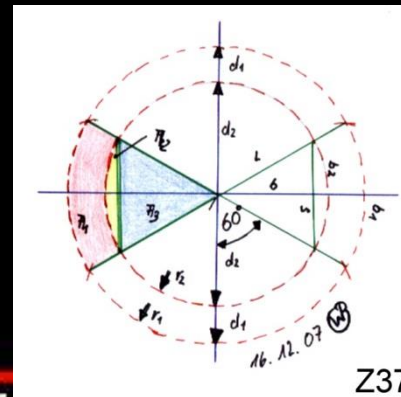

Z37

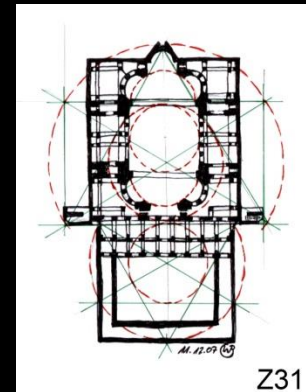

Z31

Der Totalschaden

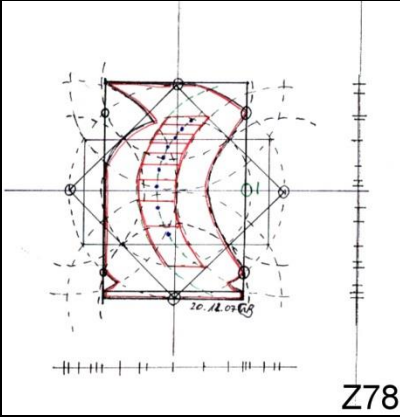

Z78

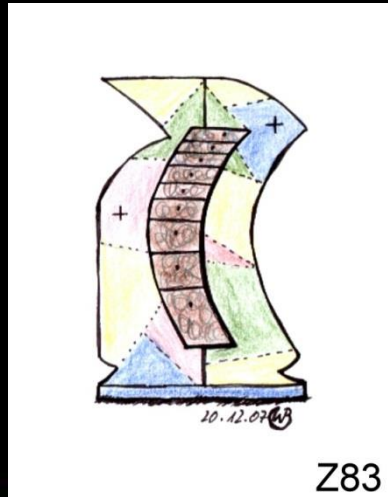

Z83

**Baufachforum**  
Wilfried Berger

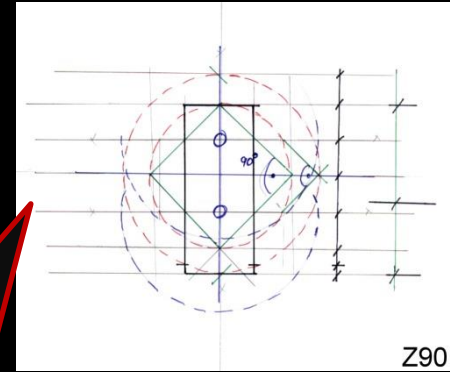
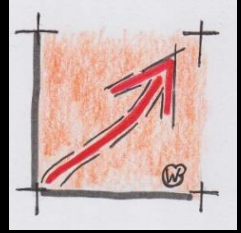

Z90

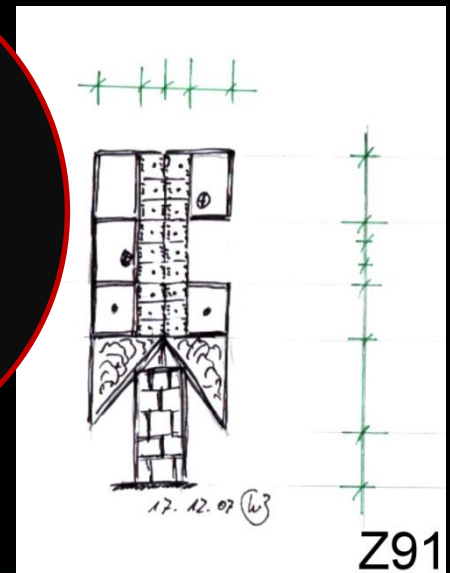

Z91

Alles nur eine Frage der Bauordnung und der Bauordnungszahlen!!!

Der Totalschaden



**Baufachforum**  
Wilfried Berger

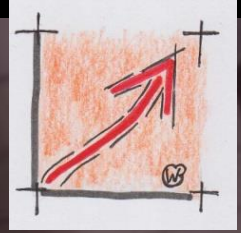

**Geiselmann 1**

Der Totalschaden



**Baufachforum**  
Wilfried Berger

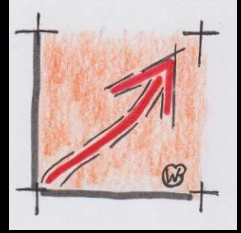

**Geiselmann 1**

Der Totalschaden



# Wo müssen wir jetzt nach dem Schaden suchen?

**Baufachforum**  
Wilfried Berger

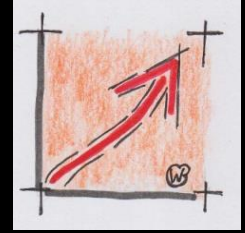

Erd-Formationsschichten  
und Frostsicherheit





Der Totalschaden



**Baufachforum**  
Wilfried Berger

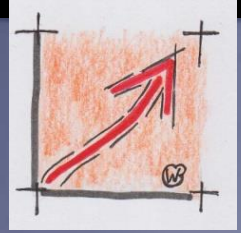

**Geiselmann 1**

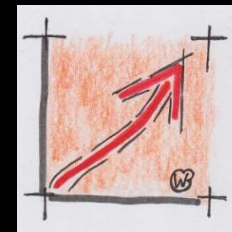

[www.BaufachForum.de](http://www.BaufachForum.de)

<b>Ordner</b> 203.19	Büro für Sachverständigenwesen und Bauschadenanalysen Wilfried Berger Otterswangerstr. 2/1 88630 Pfundorf		<b>Erstellt:</b> 24.08.2012 13:02
<b>Blatt</b> 3			<b>Aktueller Ausdruck:</b> 24.08.2012 14:15

**Firmenlogo:**

**Firma:**  
Karl Mustermann  
Musterstraße 888  
14141 Mustermannhausen  
Tel.:  
Fax:  
Mail:  
Home:

**Angaben zu diesem Blatt:**  
**Merkblatt:**  
**DIN:**  
**Verweis auf Merkblätter:**

**Lüftungs- und Heizungsbrochüre:**

*Für die Benutzer unserer Produkte:*

**Wichtig für unsere Kunden:**

Unsere Produkte sind aus unserem Hause sehr hochwertig hergestellt und eingebaut worden. Allerdings hängt die Funktion unserer Produkte davon ab, dass Sie auch richtig genutzt werden. Daher sind unsere Produkte davon Abhängig, dass sie immer ausreichend mit Frischluft und allem voran mit entsprechender warmer Luft beim Heizen konfrontiert werden. Daher ist das Heizen und Lüften Ihres Gebäudes entscheidend, ob unsere hochwertigen Produkte in Ihrem Haus funktionsfähig sind und dass an Ihrer Bausubstanz keine entscheidenden Schäden entstehen. Daher lesen Sie bitte diese Broschüre aufmerksam durch und halten Sie sich bitte an diese Vorgaben. Dann werden Sie immer und sehr lange Zeit Freude an unseren Produkten haben.

**Grundlagen der Vergangenheit:**

Die Vergangenheit unseres Bauens war geprägt von baukörperschließenden Bauteilen, die nicht Luftdicht in den Baukörper eingebaut wurden. Daher hatten wir mit dem Bewohnen der Wohnungen wenige Probleme mit Pilz und Schimmel. Wie auch mit dem Luftaustausch. Da diese aus der Vergangenheit aufgefundene Bauart von unserem Gesetzgeber revolutioniert wurde, weil damit sehr viel Energie verloren ging, wurde das Energieeinsparungsgesetz von unserem Gesetzgeber ins Leben gerufen. In der Verlängerung gegenüber unseren Bauteilen am Bau wurde die DIN 4108 Grundlage unseres Schaffens auf unseren Baustellen.

**Was hat sich verändert?**

Grundlegend ist, dass wir mit der Anpassung an unser Energieeinsparungsgesetz und der DIN 4108 gerade mit dem Austausch von Fenstern und Außentüren wie auch mit dem Dämmen der Außenwände, eine Luftdichte Bauhülle schaffen. Somit die natürliche Luftwechselrate nicht mehr gegeben ist. Unsere Wohnungen müssen somit mit dieser Veränderung von Ihnen kontrolliert gelüftet und geheizt werden. Dazu stehen Sie als Eigentümer oder Mieter der Gebäudehülle in der Verantwortung.

**Für welche Erneuerungen gilt diese Regelung?**

Es ist egal, ob Sie neue Fenster, Haustüren oder Innenausbauarbeiten vornehmen und ausführen lassen. Das Lüften und Heizen ist für alle Produkte, die Sie in Ihrem Gebäude nutzen von Bedeutung.

**Die wichtigsten Grundregeln:**

Halten Sie sich strikt an diese Broschüre, wenn Sie Modernisierungen an: Fenstern, Türen, Dämmmaßnahmen, Dachstühlen, Außenwänden (Wärmedämmverbundsysteme), Zwischendecken, Kellern und jeglicher Art von Verbesserungen an der Außenhülle des Gebäudes vornehmen.

**Wie wirken sich diese Veränderungen bei anderen Bauteilen aus?**

Grundlegend ist, dass wenn wir diese Veränderungen vornehmen, wir auch den Innenausbau diesbezüglich beeinflussen. Daher sollten mit einer Dämmung der Außenwand mit einem Wärmedämmverbundsystem und neuzeitlichen Fenstern auch die Inneneinrichtung entsprechend angepasst werden. Wichtigste Grundlage ist, dass Sie an diesen gedämmten Außenwänden keine Bilder aufhängen sollten und auch keine Möbel stellen sollten. Sollte es sich dennoch nicht vermeiden lassen, Möbel und Wohngegenstände an diesen Wänden zu platzieren, halten Sie zur Wand genügend Abstand. Richtmaß ca. 130 - 150 mm. Gleiches gilt auch bei Sitzmöbeln, die an französischen Fenstern platziert werden. Halten Sie dort vor den wärmedämmten Scheiben mindestens 600 - 800 mm Abstand um Scheibenbruch durch Schattenwirkung zu vermeiden.



**Baufachforum**  
Wilfried Berger

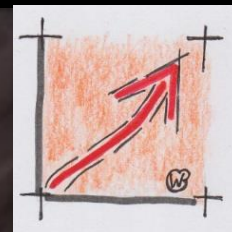

Der Totalschaden



**Baufachforum**  
Wilfried Berger

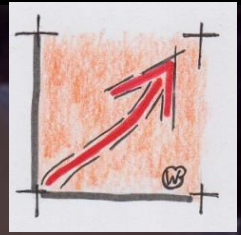

**Geiselman 1**

Der Totalschaden



# Bauphysik Fenstereinbau:

**Baufachforum**  
Wilfried Berger

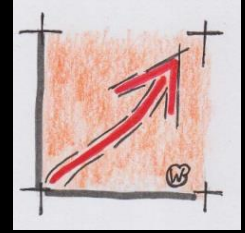

## Der zeitgemäße Fenstereinbau.

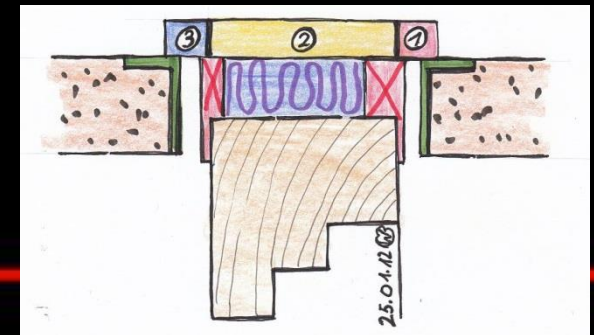
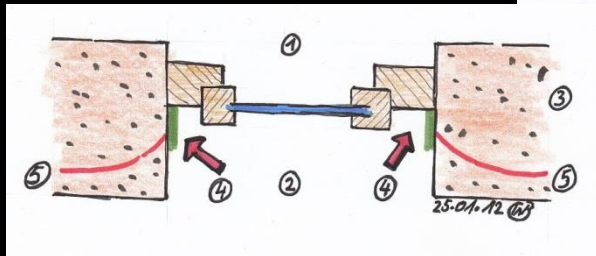
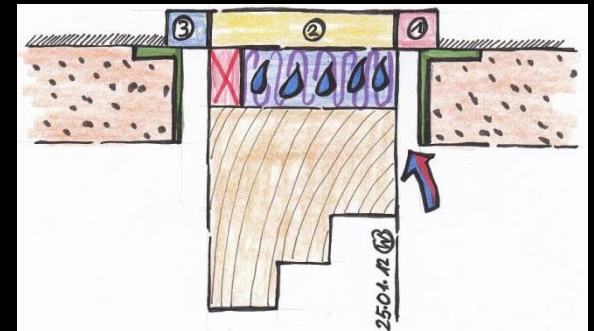
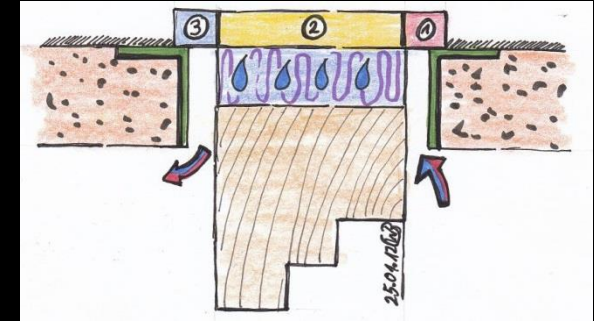
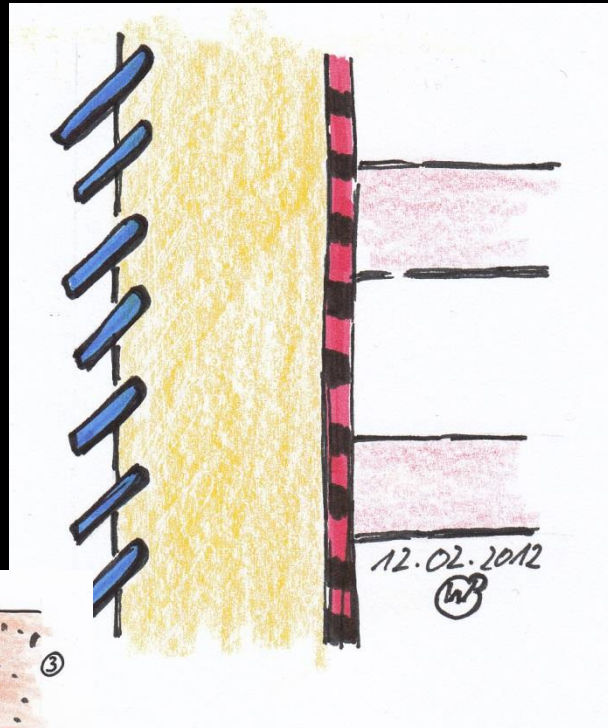
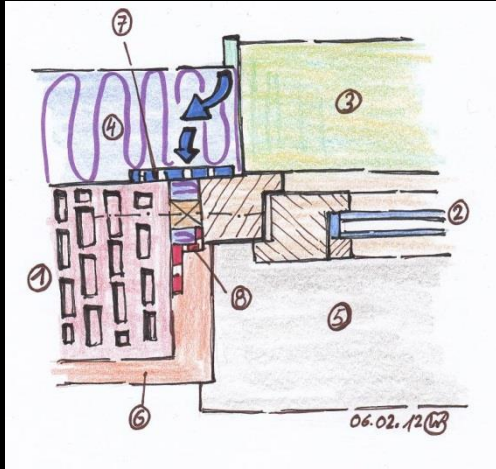

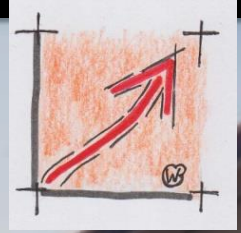

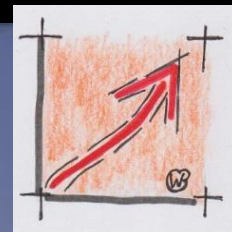

Der Totalschaden



**Baufachforum**  
Wilfried Berger

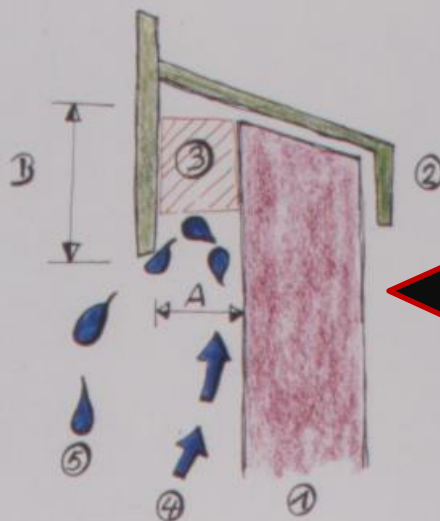
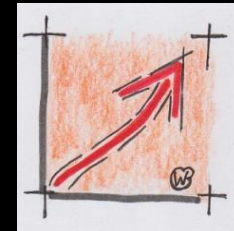

Aus dem Goldenen Schnitt!!!  
A = 50 mm  
B = 80 mm

Skizze 3-3-2-10  
23.03.2004  
WB



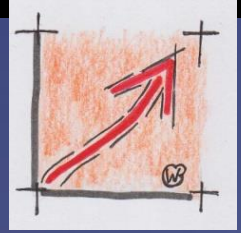

Der Totalschaden

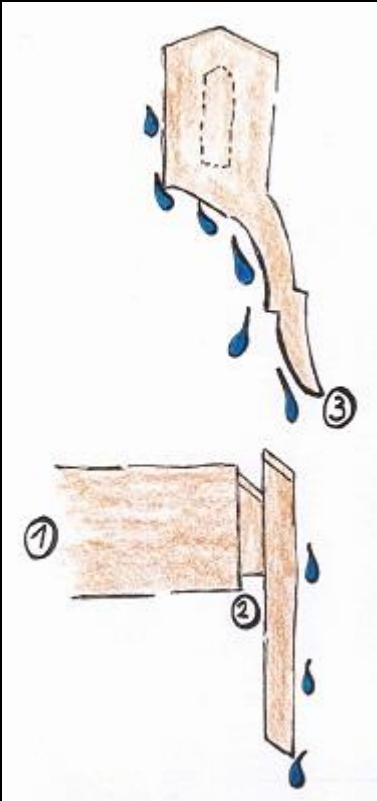

**Baufachforum**  
Wilfried Berger

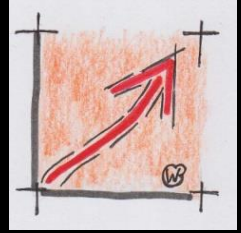

Konstruktiver  
Holzschutz

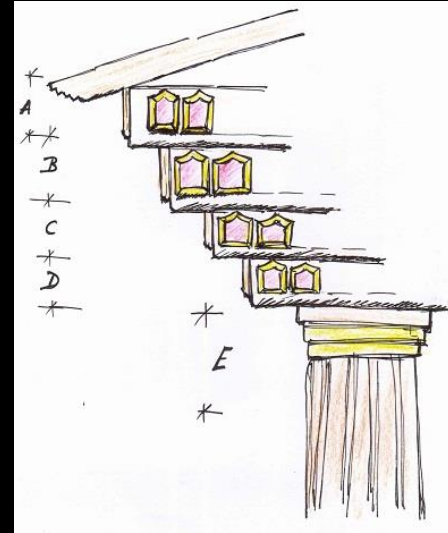



**Baufachforum**  
Wilfried Berger

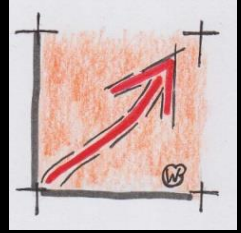

Konstruktiver  
Holzschutz.

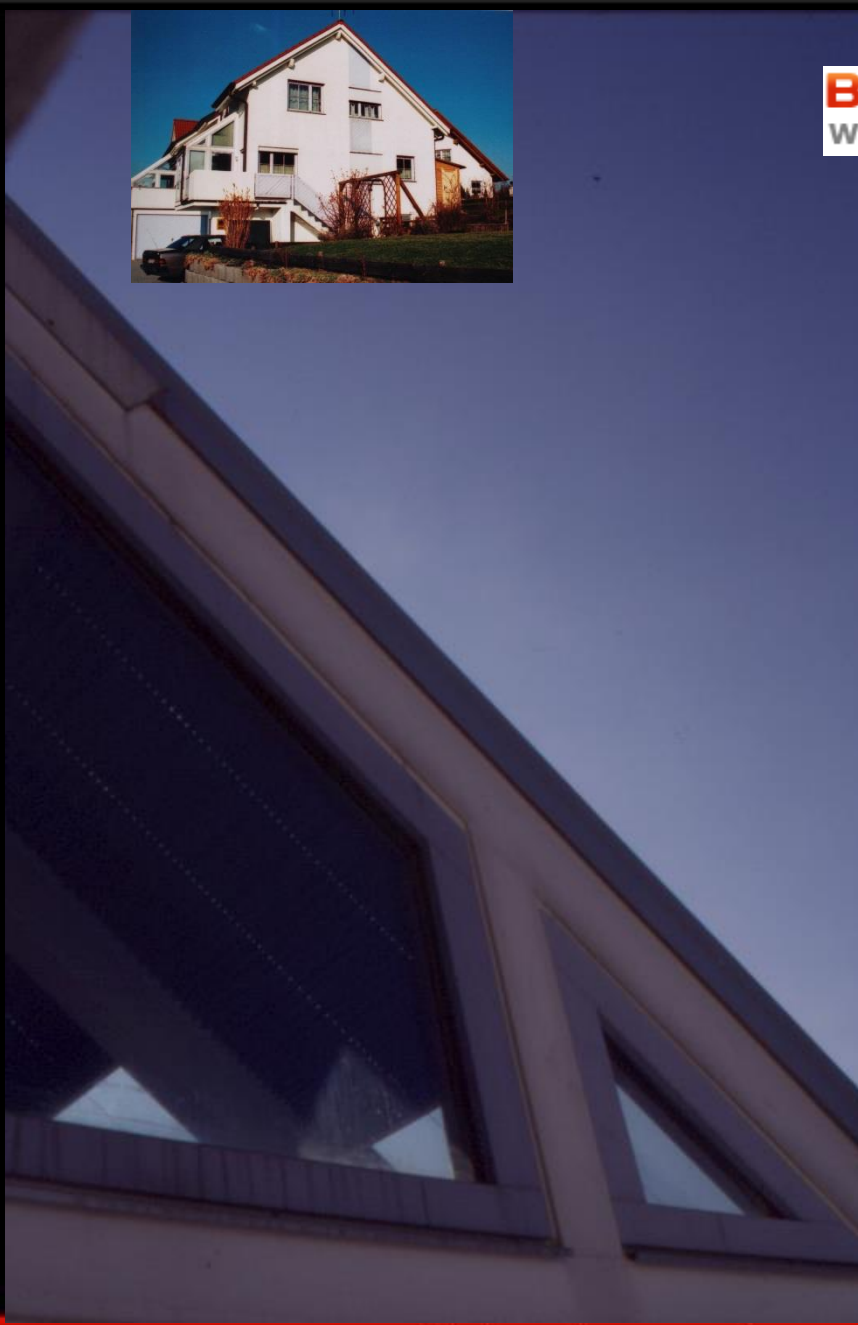

**Geiselmann 1**

Der Totalschaden



**Baufachforum**  
Wilfried Berger

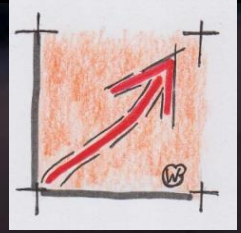

**Geiselmann 1**

Der Totalschaden



**Baufachforum**  
Wilfried Berger

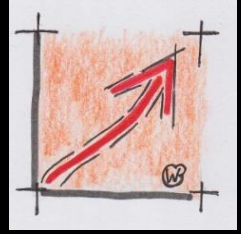

Der Totalschaden



# Holzwände:

**Baufachforum**  
Wilfried Berger

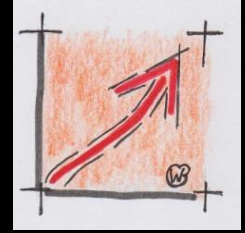

- Die Holzständerwand.
- Eine Dämmung ist unumgänglich.
- Eine Dampfbremse ist ein Muß.



Der Totalschaden



**Baufachforum**  
Wilfried Berger

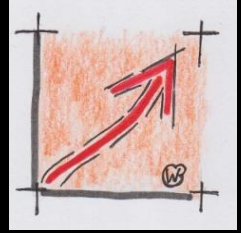

**Geiselmann 1**

Der Totalschaden



**Baufachforum**  
Wilfried Berger

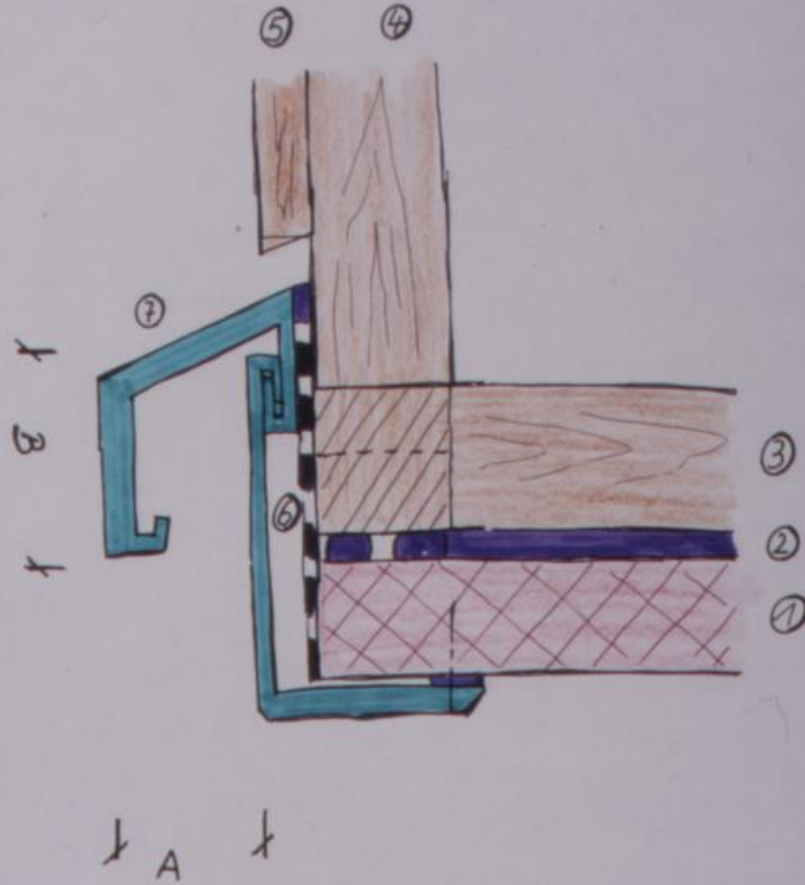
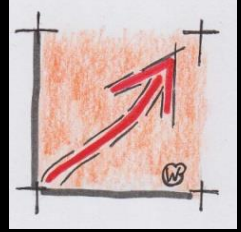

25.02.2002  
*[Signature]*



Der Totalschaden



**Baufachforum**  
Wilfried Berger

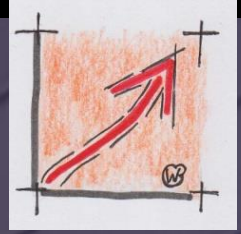

**Geiselmann 1**

Der Totalschaden



**Baufachforum**  
Wilfried Berger

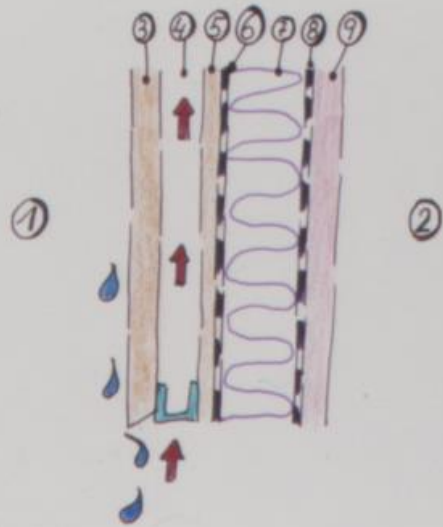
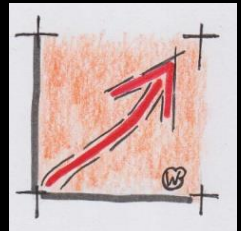

25.02.2002  
*[Signature]*

Der Totalschaden



**Baufachforum**  
Wilfried Berger

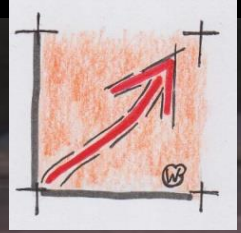

**Geiselman 1**

Der Totalschaden



**Baufachforum**  
Wilfried Berger

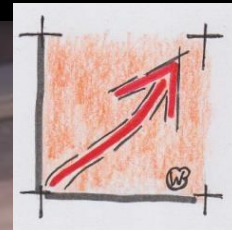

**Geiselmann 1**

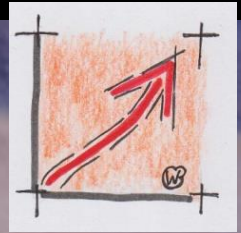

Der Totalschaden



**Baufachforum**  
Wilfried Berger

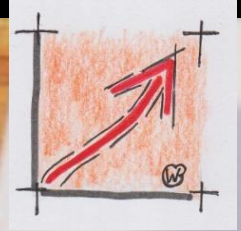

**Geiselman 1**

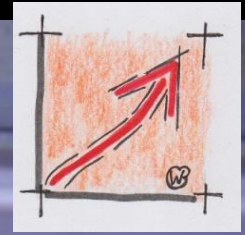

Der Totalschaden



**Baufachforum**  
Wilfried Berger

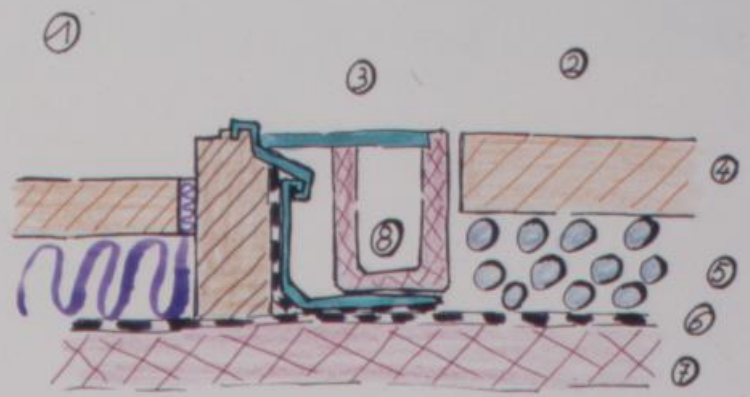
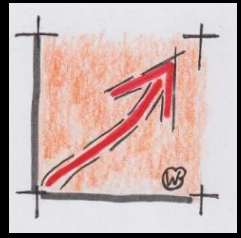

25.02.2002  
*[Signature]*



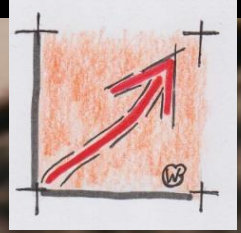

Der Totalschaden

Der Totalschaden



**Baufachforum**  
Wilfried Berger

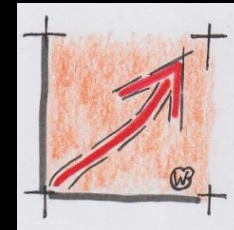

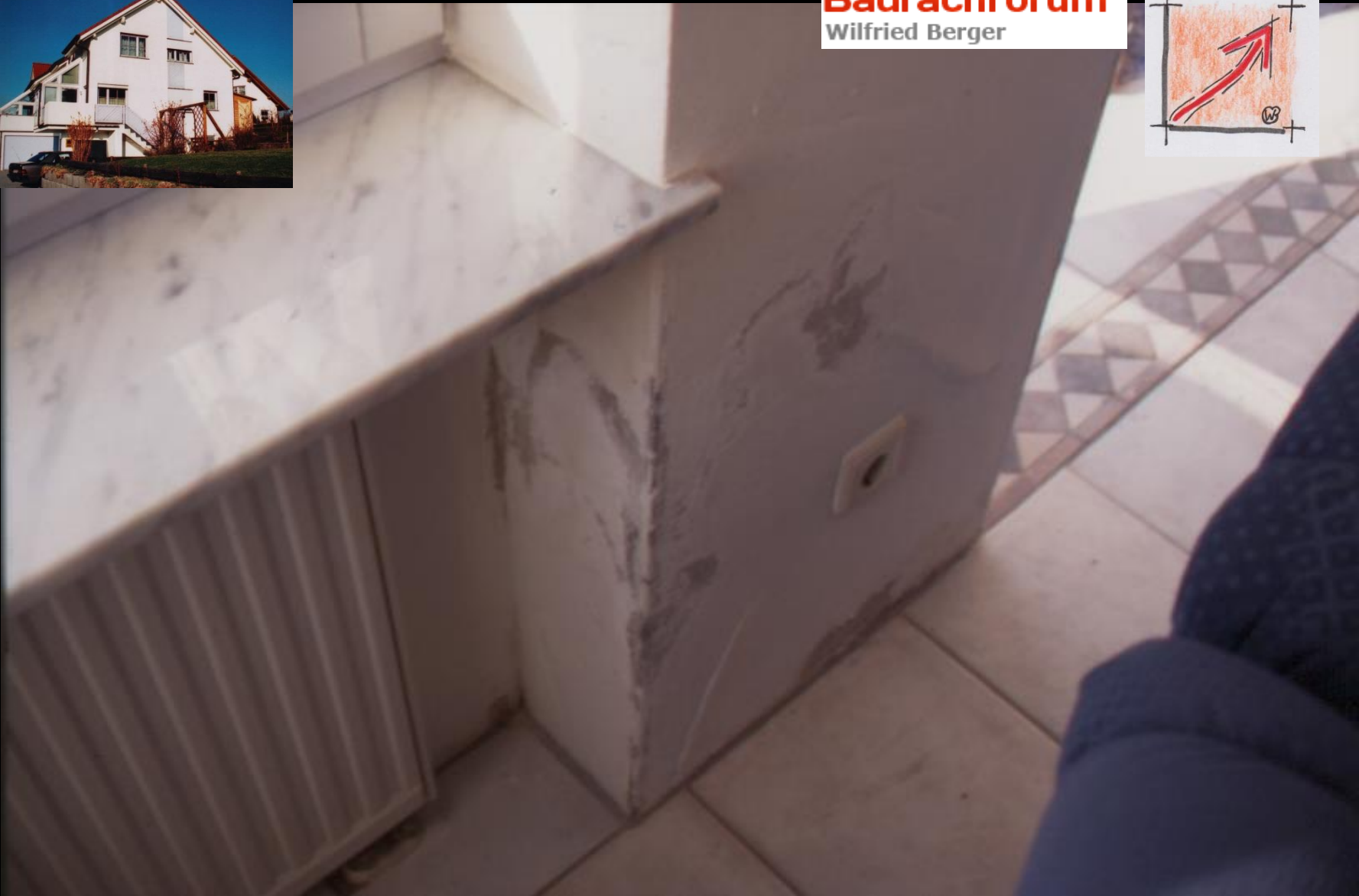
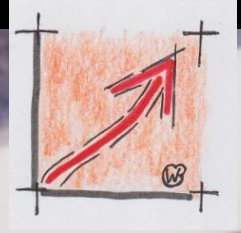

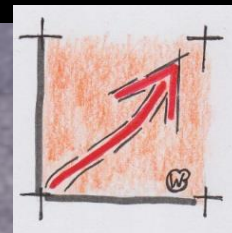



**Baufachforum**  
Wilfried Berger

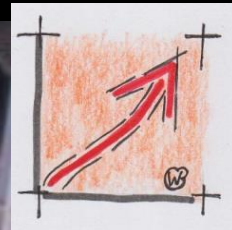

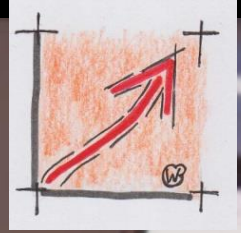

Der Totalschaden



**Baufachforum**  
Wilfried Berger

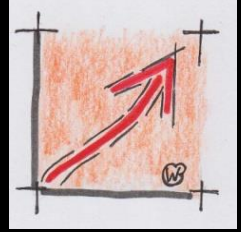

**Geiselman 1**

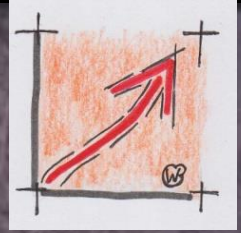



Der Totalschaden



**Baufachforum**  
Wilfried Berger

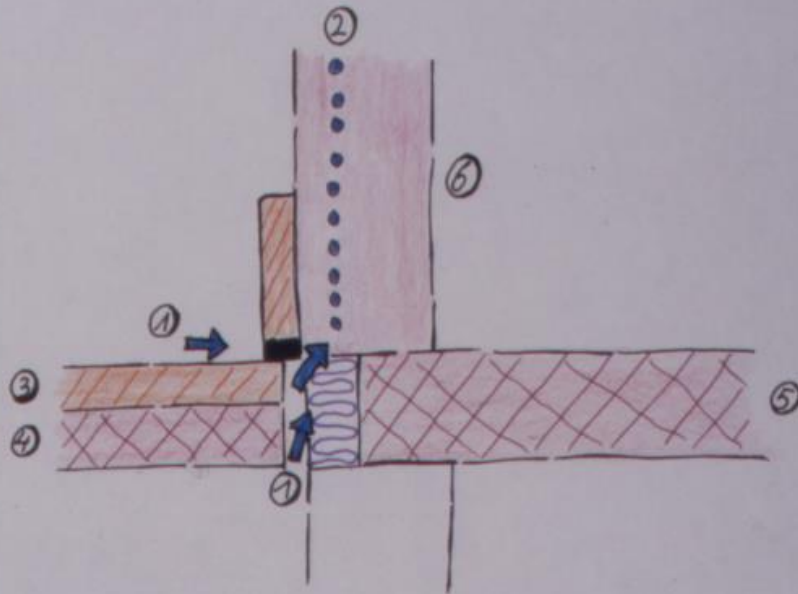
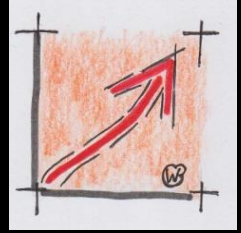

25.02.2002  
[Signature]

Der Totalschaden



Bauwerks-  
abdichtungen

**Baufachforum**  
Wilfried Berger

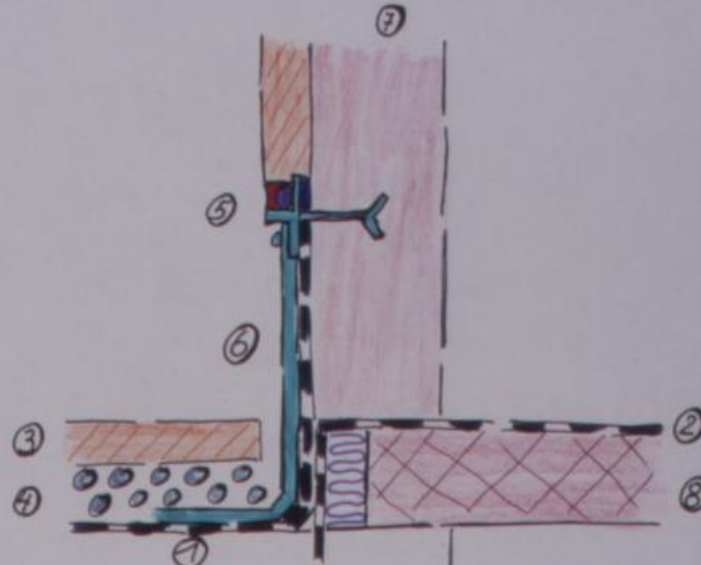
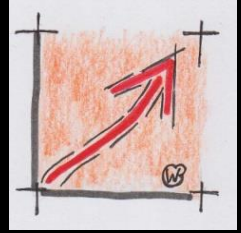

**Geiselman 1**

Der Totalschaden



**Baufachforum**  
Wilfried Berger

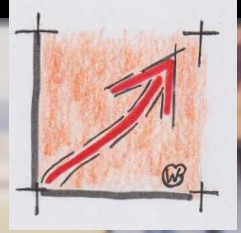

Der Totalschaden



**Baufachforum**  
Wilfried Berger

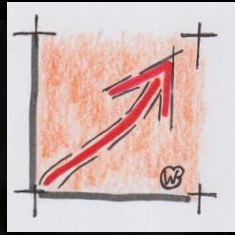

Der Totalschaden



**Baufachforum**  
Wilfried Berger

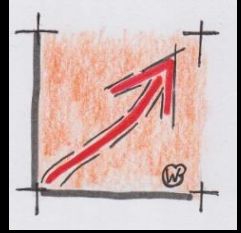

**Geiselmann 1**

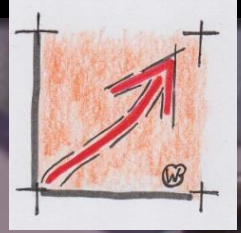

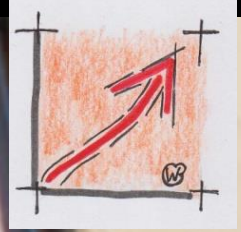

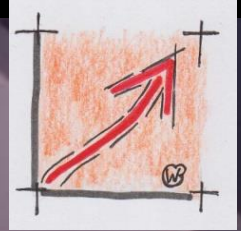



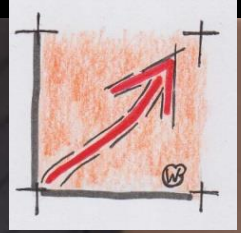

Der Totalschaden



**Baufachforum**  
Wilfried Berger

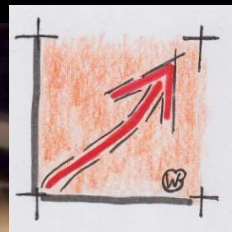

Der Totalschaden



**Baufachforum**  
Wilfried Berger

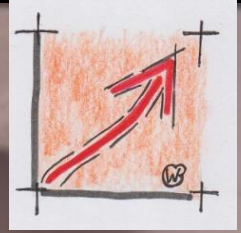

**Geiselmann 1**

Der Totalschaden



**Baufachforum**  
Wilfried Berger

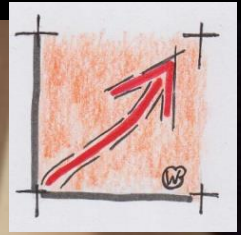

**Geiselmann 1**

Der Totalschaden



**Baufachforum**  
Wilfried Berger

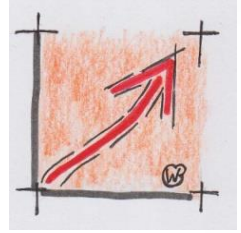

**Geiselmann 1**

Der Totalschaden



**Baufachforum**  
Wilfried Berger

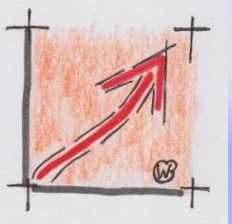

**Geiselmann 1**

Der Totalschaden



**Baufachforum**  
Wilfried Berger

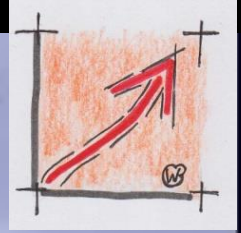

**Geiselman 1**

Der Totalschaden

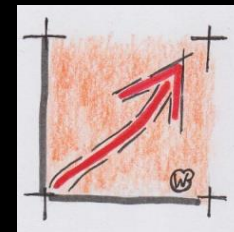

## Bauirrtümer

Habe ich denn nicht eine Kirche bestellt?

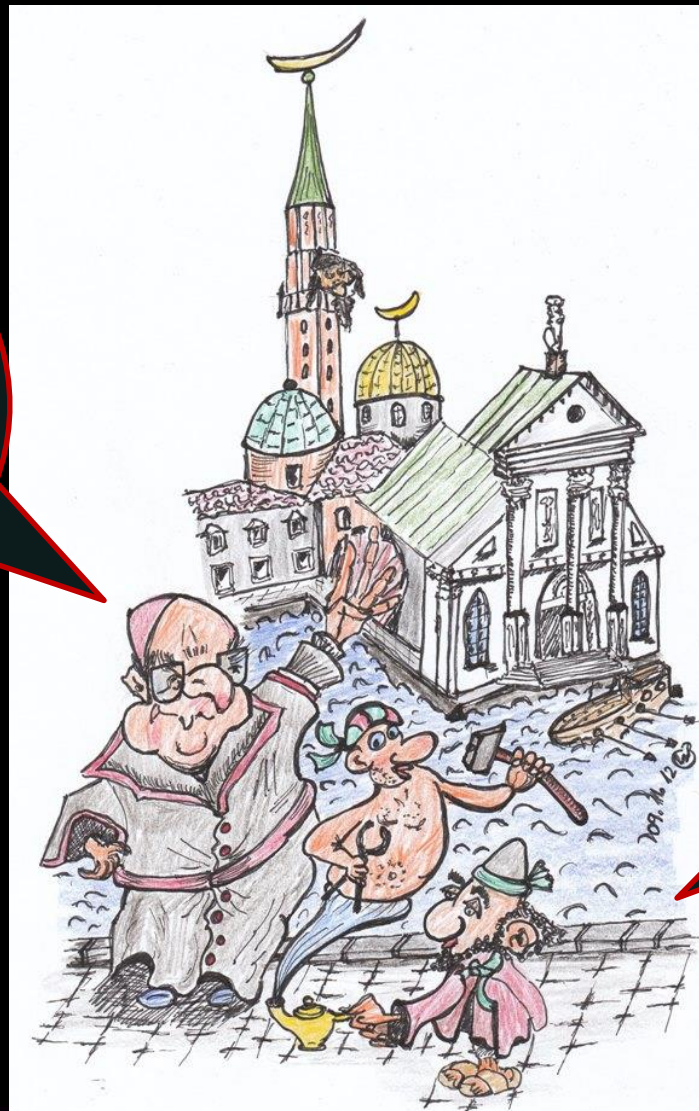

Schon!!!!!!  
Du hast nur nicht gesagt für welche Glaubensgemeinschaft?



Der Totalschaden



**Baufachforum**  
Wilfried Berger

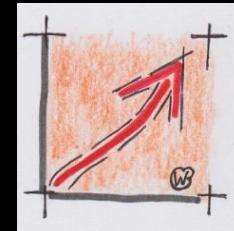

**Ich bedanke mich für Ihre  
Aufmerksamkeit.**

**Geiselman 1**